

Dušilne lopute DL-3N

Uporaba

Dušilne lopute se uporabljajo za nastavljanje pretočnih količin zraka in so prirejene za vgradnjo v sisteme okroglih in spiro kanalov.

Opis

Dušilna loputa DL-3N je sestavljena iz ohišja in lamele, ki sta iz pocinkane pločevine ter mehanizma na osovini za nastavljanje kota lamel. Lopute je možno zunanje izolirati. DL-3N ima na priklopih gumijasto tesnilo.



Dimenzije in velikosti

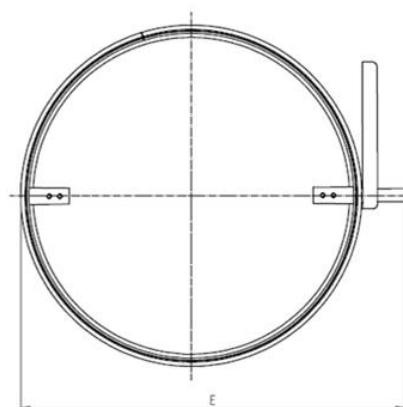
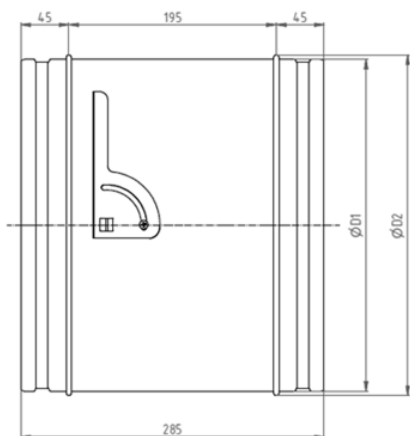

Velikost	100	125	160	200	250	315	355	400	500	630
ØD1	98	123	158	198	248	312	353	397	496	626
ØD2	104	129	164	204	254	318	358	403	502	632
E	142	167	202	242	292	356	397	441	540	670

Diagram padca tlaka

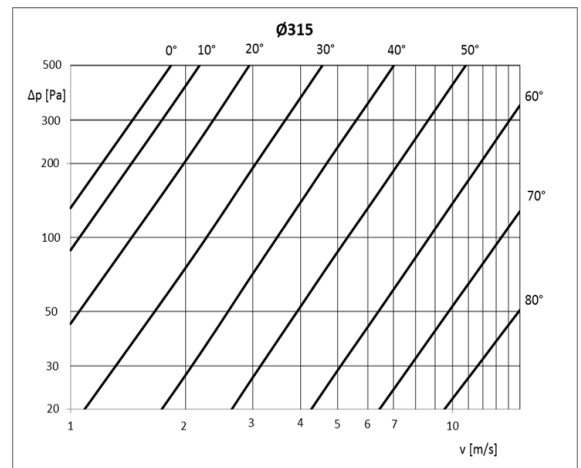
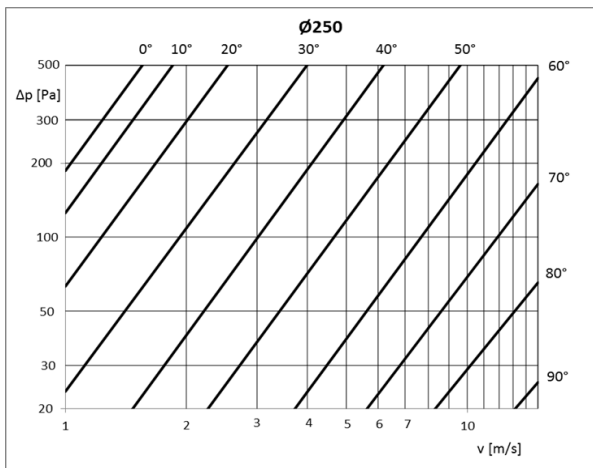
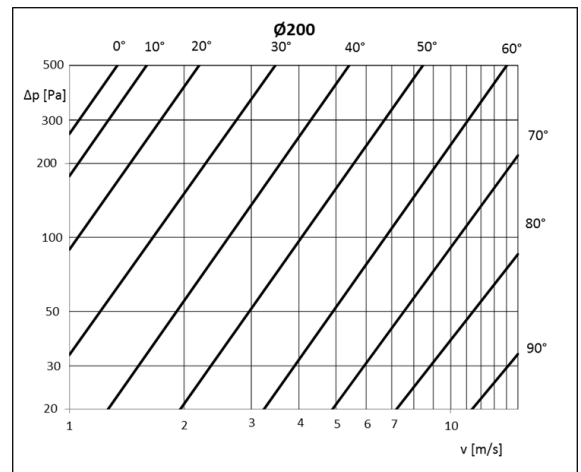
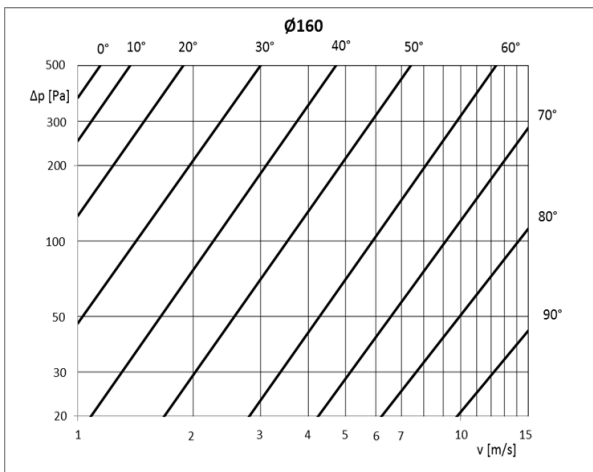
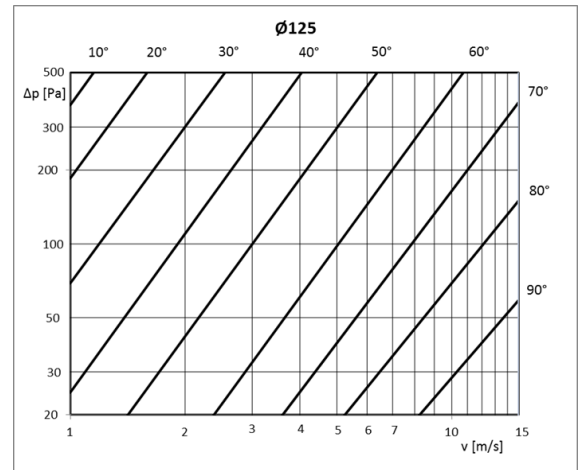
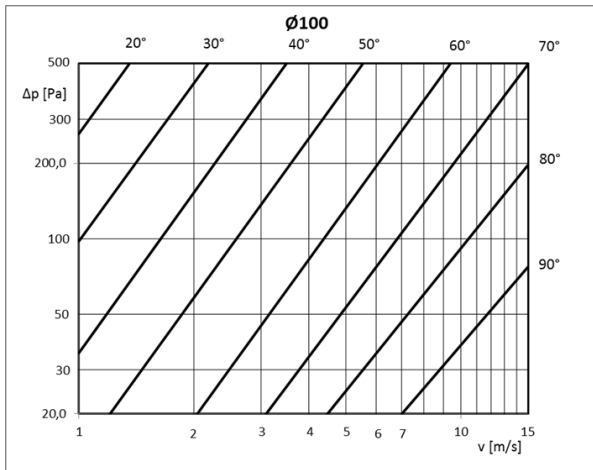
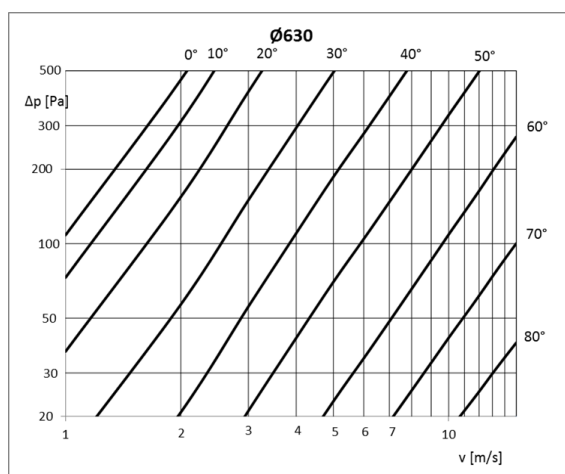
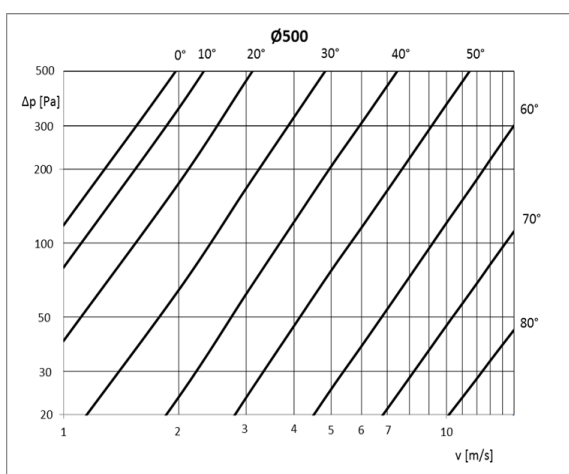
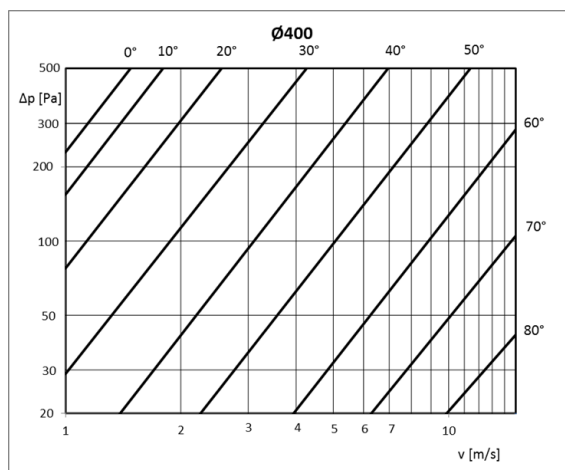
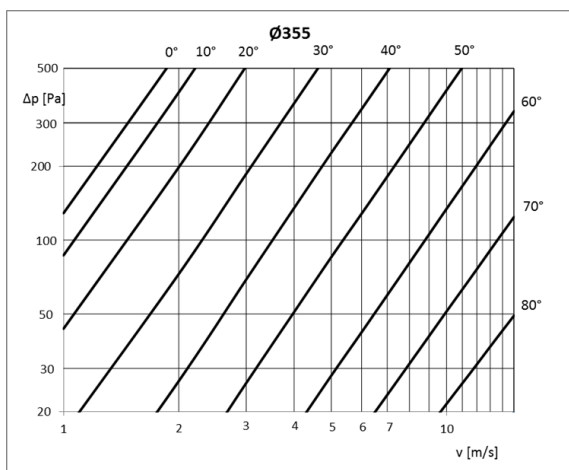
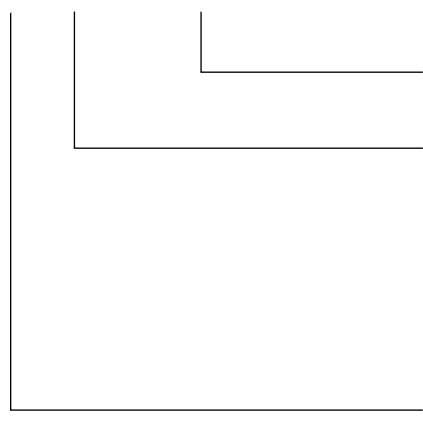

Diagram padca tlaka



Ključ za naročanje

DL-3N / R / velikost 200



Velikost (g. tabelo)

R Ročna izvedba

B1 Motorni pogon LM 24A

B2 Motorni pogon LM 230A

B3 Motorni pogon LM 24A SR (zvezna regulacija)

DL-3N Zrakotesna loputa